

# User Manual

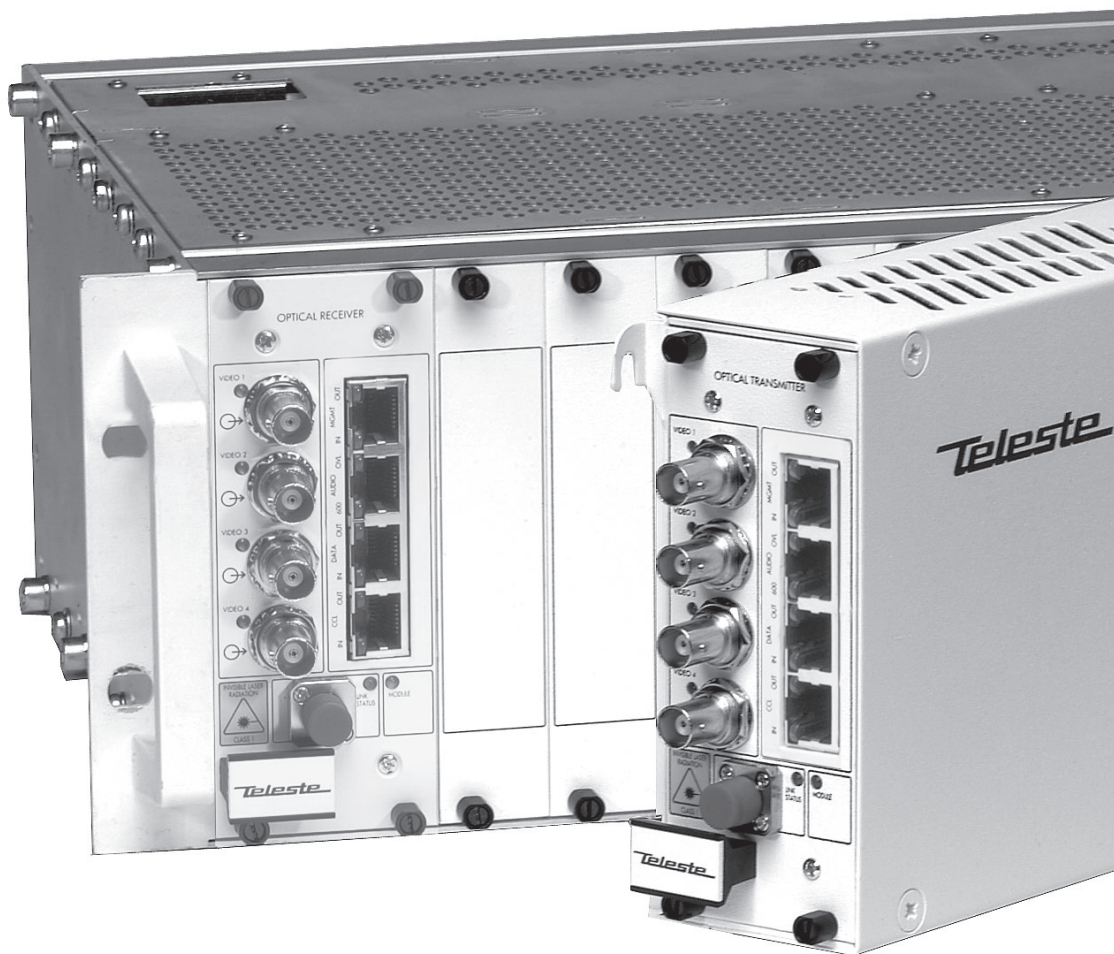

## CRT441 & CRR441 version H

---

# Contents

<b>Introduction</b> .....	<b>1</b>
<b>Optical Transmitter CRT441</b> .....	<b>2</b>
General .....	2
Frame Installation .....	2
Video Inputs and Indicator Leds .....	2
Super Video Connection .....	3
Stand-Alone Installation.....	4
Data Connections .....	5
Management (MGMT) Data Connection.....	6
Audio Connection .....	7
Contact Closure Loop (CCL) Connection .....	8
Link Status and Module Indicator Leds .....	9
Alarm Connections .....	9
Video Source Alarm (VSA) .....	10
Fibre Connection .....	10
<b>Optical Receiver CRR441</b> .....	<b>11</b>
General .....	11
Frame Installation .....	11
Video Outputs and Indicator Leds .....	11
Stand-Alone Installation.....	12
Data Connections .....	13
Management (MGMT) Data Connection.....	14
Audio Connection .....	15
Contact Closure Loop (CCL) Connection .....	16
Link Status and Module Indicator Leds .....	17
Alarm Connections .....	17
Video Source Alarm (VSA) .....	18
Fibre Connection .....	18
<b>Copyright Acknowledgements</b> .....	<b>19</b>

---

# CFO441 Single mode 4 Channel Digital Units for Uni-directional Video and Bi-directional Audio, Data & Contact Closure, In-band Management

## Introduction

The **CFO441** is a four channel uni-directional video link with two bi-directional data, one audio and one contact closure channels.

**PAL**, **NTSC** and **SECAM** video formats are supported to provide a transparent video transmission. It is also possible to transmit S-video channels (2 pcs) that comprises separate luminance (**Y**) and chrominance (**C**) signals.

All common data protocols are supported as well and are easily configured by terminal software interface.

Optical transmission is based on **FP** laser operation. The multiplexed data stream of 540 Mb/s enables a full quality and a real-time video transmission in one singlemode fiber up to 40 km typical transmission distance.

**All CFO441 units are compatible with all CFO rack systems. Stand-alone options are available with the CMA021 module adapter and a separate mains adapter.**

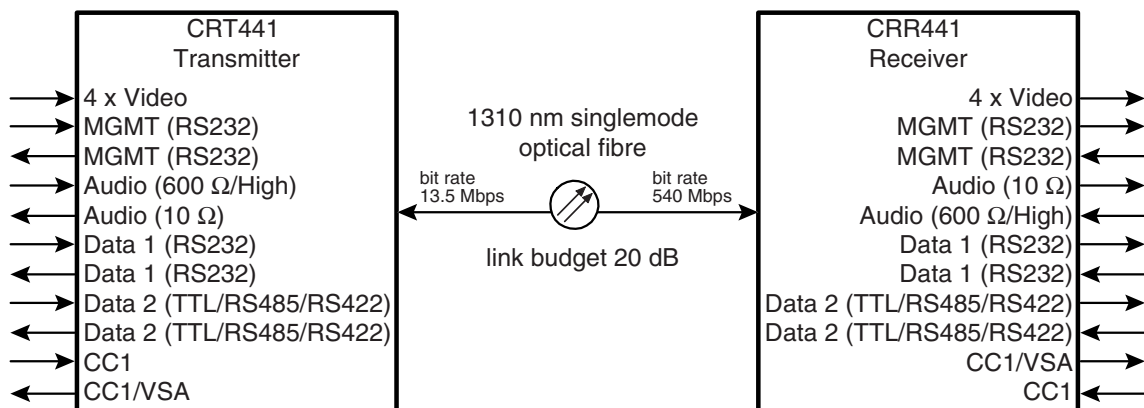

**Note! Version H units are not compatible with earlier versions (E & F).**

## OPTICAL TRANSMITTER CRT441

**CAUTION:**  
**THIS OPTICAL UNIT USES CLASS 1 LASER DIODE.**  
**DO NOT STARE INTO BEAM OR VIEW DIRECTLY WITH OPTICAL**  
**INSTRUMENTS. APPLICABLE STANDARD**  
**IEC825-2: 1993**

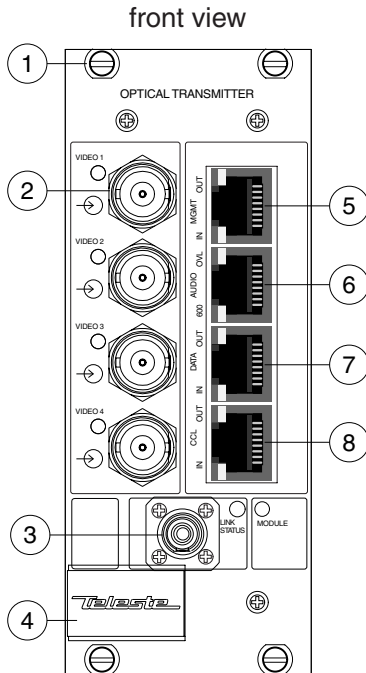

**Picture 1.**

### **CRT441 Optical Transmitter**

- 1) Locking screw.
- 2) Video input (BNC female) and video indicator (led).
- 3) Optical input/output (FC/PC).
- 4) Handle.
- 5) MGMT connector (RJ-45 female).
- 6) AUDIO connector (RJ-45 female).
- 7) DATA connector (RJ-45 female).
- 8) CCL connector (RJ-45 female).

## GENERAL

The **CRT441** is a four channel optical transmitter for uni-directional video transmission with two bi-directional data, one audio and one contact closure channel in a singlemode fibre. The current consumption is max. 800 mA (+12V DC).

## FRAME INSTALLATION

The module is to be pushed along the guide rails into the installation frame (e.g. **CSR216** or **316** series) and secured with the four locking screws. The unit can be freely positioned in any slot in the frame. The empty positions in the frame should be blanked off with cover plates.

The supply voltage is to be provided by a **CPS384** power supply unit.

## VIDEO INPUTS AND INDICATOR LEDS

The impedance of the video inputs (BNC female) is 75  $\Omega$ . The nominal input level is 1 Vpp.

Each video input (1...4) is equipped with the dual colour VIDEO led on the front panel. In case a video signal is present and in nominal level (and the unit detects video synchronization pulses), the VIDEO led is green. If there is no video signal, or the video level is too low, the VIDEO led is yellow.

The video inputs (1...4) are switched to the **Normal video** or **Data/S-video** usage by **DIP** switches on the bottom of the unit. The default factory setting is normal video.

## S-VIDEO CONNECTION

It is also possible to transmit two **S-video** signals that comprises separate luminance (**Y**) and chrominance (**C**) signals. This, however, uses two channels per one transmission channel as shown in picture 2 below. Connect **Y** and **C** signals to any of video inputs (1...4). Make sure that the **Y** and **C** connections are corresponding both at **CRT** and **CRR**.

*Note! The video LEDs (1...4) on the front panel are locked to the synch pulse transmitted in the Y channels.*

## DIP SWITCHES

**Normal video** position is meant for normal composite video or S-video's luminance (**Y**) signal transmission.

**Data/S-video** position is meant when connect **CSX** series multiplexer in system or when transmit s-video's chrominance (**C**) signal. The DIP switch at the rear of unit is meant for unit's programming. The default factory setting is "normal".

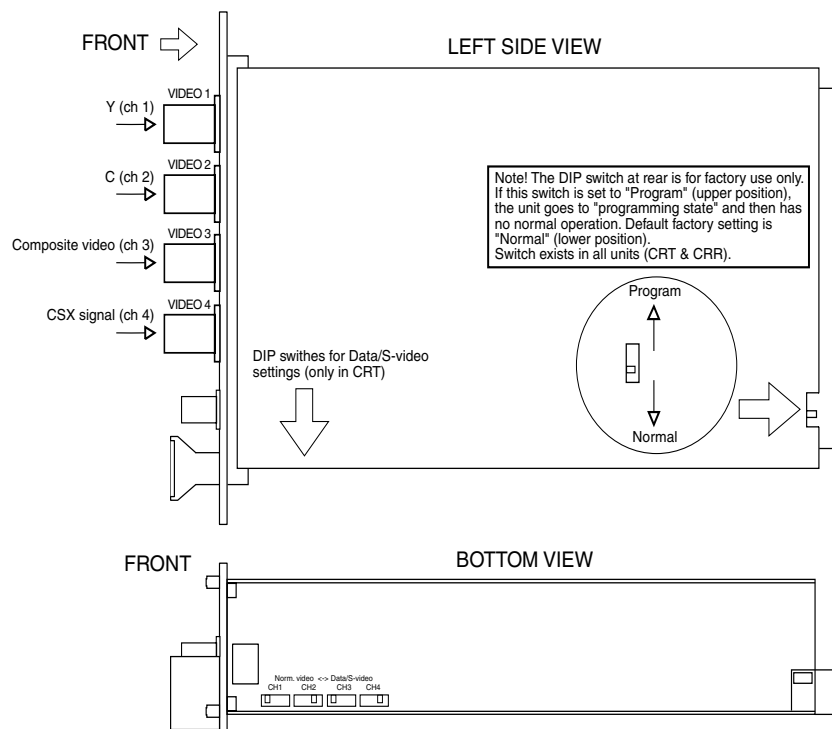

**Picture 2.**

DIP switch settings example for Data / Super Video transmission.

*Note! No adjustments are needed on the receiver **CRR441** for the **S-video** reception.*

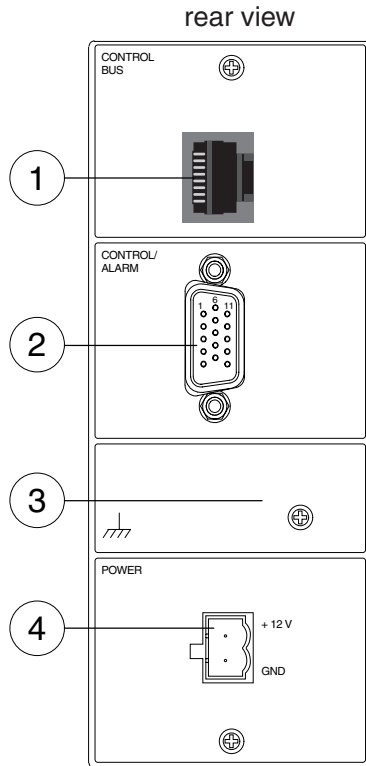

**Picture 3.**

**CMA021 Module Adapter**

- 1) Control bus for management systems (RJ-45 female), not in use.
- 2) Control / alarm interface connector (HD15 female).
- 3) Grounding connection.
- 4) Supply voltage connector.

**STAND-ALONE INSTALLATION**

The unit can be installed for stand-alone use by using a **CMA021** module adapter (see picture 3). The module should be mounted to a vertical surface. The 12V DC supply voltage is supplied by the means of a separate mains adapter with a regulated output, (e.g. **CPS231**). The permitted supply voltage range is 10.5...14V DC. The permitted operational temperature range is from -10 to +55 °C.

Pin	Signal
1	Not used
2	Not used
3	Not used
4	Not used
5	+12 V DC output
6	A - alarm
7	B - alarm
8	CTRL1 (CFO address bus data)
9	CTRL2 (CFO address bus clk)
10	Ground
11	Not used
12	Not used
13	Not used
14	Not used
15	Not used

**Table 1.**

Pin information for the HD15 female connector of the **CMA021** module adapter (with CRT441 installed).

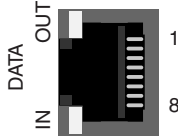

**Picture 4.**

The DATA connector (RJ-45 female).  
 DATA OUT led indicates status of (data ch 2) outgoing data signal and DATA IN led indicates status of (data ch 2) incoming data signal.

## DATA CONNECTIONS

The DATA connector contains two bi-directional data channels (CRT <--> CRR). The connector in use is a **RJ-45 female** connector (see picture 4 and table 3 for detailed description). The recommended cable for DATA connection is **CIC603** (RJ-45/open wires, see table 2 for detailed description). Data channel 1 is always in **RS232** mode. The desired data mode for data channel 2 can be selected by using a PC and any terminal type communication software (see separate documentation for **CFO441** terminal software). See table 4 for available data modes for data channel 2. The default factory settings are **RS485-2w + Dwell time 75µs**. The **DATA IN/OUT** leds indicates the status of data (ch 2) stream and they are also operating synchronously with the data stream. See table 5 for explanation of DATA connector's leds.

Pin	Wire color
1	White / green stripe
2	Green
3	White / orange stripe
4	Blue
5	White / blue stripe
6	Orange
7	White / brown stripe
8	Brown

**Table 2.**

CIC603 cable's pinout / wire colors (RJ-45 male / open wires).

Pin	Signal	TTL	RS422	RS485-2w	RS485-4w	RS232
1	Data 2		in (-)	in / out (-)	in (-)	
2	Data 2	in	in (+)	in / out (+)	in (+)	
3	Data 2		out (+)		out (+)	
4	Data 2	out				
5	Ground					
6	Data 2		out (-)		out (-)	
7	Data 1					out
8	Data 1					in

**Table 3.**

DATA connector's pinout (RJ-45 female).

Mode	Input termination options
TTL	None
RS422	No term (only failsafe)
	Hard bias
	Line bias (120 Ω line impedance)
RS485 - 2w	No term (only failsafe) + Dwell time adjustable 50...10000µs
	Hard bias
	Line bias (120 Ω line impedance)
RS485 - 4w	No term (only failsafe)
	Hard bias
	Line bias (120 Ω line impedance)

**Table 4.**

Available datamodes for data channel 2.

Led	Colour	Status
DATA OUT	Green	Data "1"
	Yellow	Data "0"
DATA IN	Green	Data "1"
	Yellow	Data "0"

**Table 5.**

DATA connector (RJ-45 female) / indicator leds.

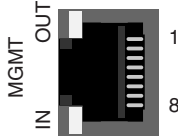

**Picture 5.**

The MGMT connector (RJ-45 female). MGMT OUT led indicates status of outgoing MGMT data signal and MGMT IN led indicates status of incoming MGMT data signal.

## MANAGEMENT (MGMT) DATA CONNECTION

The MGMT connector contains one bi-directional MGMT data channel (**RS232**). The MGMT connection allows locally or remotely (in-band connection via fibre) configuration and monitoring of **CFO441** unit by using a PC and any terminal type communication software (see separate documentation for **CFO441** terminal software).

The connector in use is a **RJ-45 female** connector (see picture 5 and table 7 for detailed description). The recommended cable for MGMT connection is **CIC503** (RJ-45 male/D9 female, see table 6 for detailed description).

The **MGMT IN/OUT** leds indicates the status of MGMT data stream and they are also operating synchronously with the data stream. See table 8 for explanation of MGMT connector's leds.

Pin	RJ-45	D9
1	-	-
2	MGMT out	MGMT in
3	MGMT in	MGMT out
4	-	-
5	Ground	Ground
6	-	-
7	-	-
8	-	-
9	-	-

**Table 6.**

CIC503 cable's pinout (RJ-45 male / D9 female).

Pin	Signal
1	Ground
2	MGMT out (RS232)
3	MGMT in (RS232)
4	Ground
5	Ground
6	Ground
7	Ground
8	Ground

**Table 7.**

MGMT connector's pinout (RJ-45 female).

Led	Colour	Status
MGMT OUT	Green	Data "1"
	Yellow	Data "0"
MGMT IN	Green	Data "1"
	Yellow	Data "0"

**Table 8.**

MGMT connector (RJ-45 female) / indicator leds.



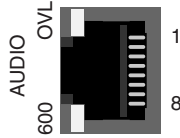

**Picture 6.**

The AUDIO connector (RJ-45 female). AUDIO OVL led indicates status of audio signal level and AUDIO 600 led indicates status of audio input impedance.

## AUDIO CONNECTION

The AUDIO connector contains one bi-directional audio channel line (CRT <--> CRR). The audio input impedance can be set to high impedance (>10 kΩ) or 600 Ω by using a PC and any terminal type communication software (see separate documentation for **CFO441** terminal software). The default factory setting is **600 Ω**.

The connector in use is a **RJ-45 female** connector (see picture 6 and table 10 for detailed description) and the cable in use is e.g. **CIC603** (RJ-45/open wires, see table 9 for detailed description).

The **AUDIO 600** led indicates the status of audio impedance and the **AUDIO OVL** led indicates the status of audio level. See table 11 for explanation of AUDIO connector's leds.

Pin	Wire color
1	White / green stripe
2	Green
3	White / orange stripe
4	Blue
5	White / blue stripe
6	Orange
7	White / brown stripe
8	Brown

**Table 9.**

CIC603 cable's pinout / wire colors (RJ-45 male / open wires).

Pin	Signal
1	Ground
2	Ground
3	Audio output +
4	Audio output -
5	Ground
6	Ground
7	Audio input +
8	Audio input -

**Table 10.**

AUDIO connector's pinout (RJ-45 female).

Led	Color	Status
AUDIO OVL	Green	Audio signal level is good
	Yellow	Audio signal level is too high
	No light	Audio signal is missing
AUDIO 600	Green	Audio input impedance is 600 Ω
	Yellow	Audio input impedance is >10 kΩ

**Table 11.**

AUDIO connector (RJ-45 female) / indicator leds.

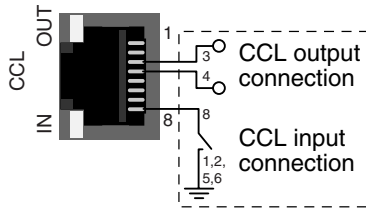

**Picture 7.**

The CCL connector (RJ-45 female). CCL OUT led indicates status of CCL output signal and CCL IN led indicates status of CCL input signal.

### CONTACT CLOSURE LOOP (CCL) CONNECTION

The CCL connector contains one bi-directional contact closure channel line (CRT <--> CRR). The CCL input is a normal short circuit on/off - signal between connector's contact pins 8 and ground (pins 1, 2, 5 or 6).

The CCL output is a normal output relay (dry contact) on/off - signal between connector's contact pins 3 and 4.

The connector in use is a **RJ-45 female** connector (see picture 7 and table 13 for detailed description) and the cable in use is e.g. **CIC603** (see table 12 for detailed description).

The **CCL IN/OUT** leds indicates the status of CCL connection. See table 14 for explanation of CCL connector's leds.

The CCL output channel can be alternatively configured for VSA usage. The default factory setting is CCL usage (**CC1=CC1**).

Pin	Wire color
1	White / green stripe
2	Green
3	White / orange stripe
4	Blue
5	White / blue stripe
6	Orange
7	White / brown stripe
8	Brown

**Table 12.**

CIC603 cable's pinout / wire colors (RJ-45 male / open wires).

Pin	Signal
1	Ground
2	Ground
3	CCL output (output relay)
4	CCL output (output relay)
5	Ground
6	Ground
7	NC
8	CCL input (photodiode cathode)

**Table 13.**

CCL connector's pinout (RJ-45 female).

Led	Color	Status
CCL OUT	Green	CCL output is closed
	Yellow	CCL output is open
CCL IN	Green	CCL input is closed (pin 8 to ground)
	Yellow	CCL input is open

**Table 14.**

CCL connector's leds / indicator lights (RJ-45 female).

## LINK STATUS AND MODULE INDICATOR LEDS

When the optical input signal level is adequate and in synchronization to input data is achieved, the LINK STATUS led on the front panel is green. If optical input signal level is adequate, but no synchronization is achieved the LINK STATUS led blinks green/yellow. If optical input signal is missing or it's level is too low, the the LINK STATUS led is yellow.

When the supply voltage is not in the permitted range (10.5...14 V DC) or there is a transmitter laser failure, the MODULE led colour on the front panel is red. During normal operation MODULE led is blinking green (blinking indicates embedded software is working properly).

## ALARM CONNECTIONS

All alarms at the rear connector of the unit are low open collector outputs, with the capability of 30 V/10 mA switching.

Alarm	Description	Reason
A	Hardware failure	TX laser failure Supply voltage is not in the permitted range
B	Link status alarm	Input optical signal is too low No synchronisation achieved to input data

**Table 15.**

Open collector alarms.

*Note! At the bottom of unit is located a DIP switch for factory use only (see picture 2). If this switch is set to "Program" (upper position), the unit goes to "programming state" and then has no normal operation. Default factory setting is "Normal" (lower position).*

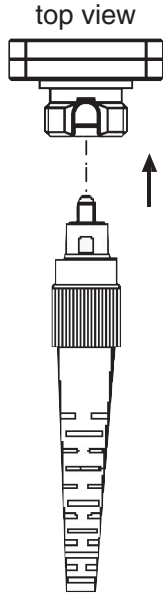

**Picture 8.**  
**FC/PC Connectors**  
 Make sure the key is aligned in the slot properly before tightening!

## VIDEO SOURCE ALARM (VSA)

The CCL output channel can be alternatively configured for VSA usage. When VSA mode is enabled and CRT's video input is missing (link otherwise operates normally, but e.g. only the camera is broken), the **CCL OUT** led blinks yellow and CCL output pins are closed. VSA have no effect to CRT's CCL input i.e. it can be used normally to transmit CCL information to CRR if VSA is not activated at CRR. In case when VSA is enabled at the same time in both CRT and CRR, then CCL channels are not available for other use. The VSA function can be set on/off by using a PC and any terminal type communication software (see separate documentation for **CFO441** terminal software).

See table 16 for explanation of CCL connector's OUT led when VSA function is set active.

*Note! Video detection has 20 sec delay before VIDEO SOURCE ALARM is activated / inactivated.*

Led	Color	Status
CCL OUT	Green on/off blinking	Video OK
	Yellow on/off blinking	Video missing

**Table 16.**

CCL connector (RJ-45 female) / CCL OUT indicator led when VSA is enabled.

## FIBRE CONNECTION

The optical connector is of the type **FC/PC** (see picture 8). The optical output level is constant and cannot be adjusted. The nominal optical output level is  $-1$  dBm (maximum optical input level for return signal is  $-1$  dBm). The link budget for both transmission directions is 20 dB. The operating wavelength is 1310 nm.

When installing the fibre optic cable, do not exceed the minimum bending radius when connecting cable to the system.

*Note! For correct optical operation ensure that all optical connectors are cleaned immediately before mating. Connectors should always be cleaned using high purity alcohol (e.g. methyl or isopropyl alcohol). Dry the surfaces using clean compressed air or other equivalent pressurised gas. The optical connectors on the equipment should always be protected with dustcaps when there is no fibre inserted.*

## OPTICAL RECEIVER CRR441

**CAUTION:**  
THIS OPTICAL UNIT USES CLASS 1 LASER DIODE.  
DO NOT STARE INTO BEAM OR VIEW DIRECTLY WITH OPTICAL  
INSTRUMENTS. APPLICABLE STANDARD  
IEC825-2: 1993

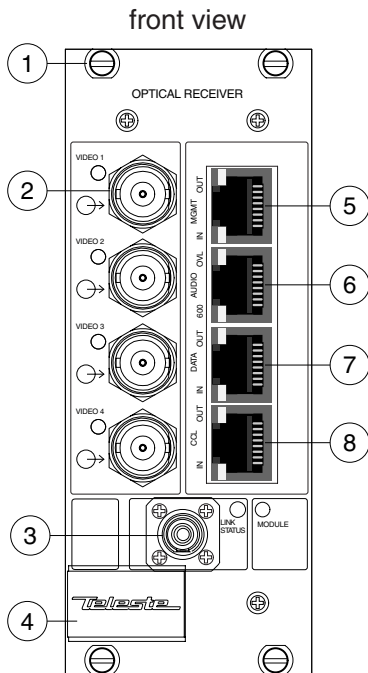

**Picture 1.**

### **CRR441** Optical Receiver

- 1) Locking screw.
- 2) Video output (BNC female) and video indicator (led).
- 3) Optical input/output (FC/PC).
- 4) Handle.
- 5) MGMT connector (RJ-45 female).
- 6) AUDIO connector (RJ-45 female).
- 7) DATA connector (RJ-45 female).
- 8) CCL connector (RJ-45 female).

## GENERAL

The **CRT441** is a four channel optical receiver for uni-directional video transmission with two bi-directional data, one audio and one contact closure channel in a singlemode fibre. The current consumption is max. 800 mA (+12V DC).

## FRAME INSTALLATION

The module is to be pushed along the guide rails into the installation frame (e.g. **CSR216** or **316** series) and secured with the four locking screws. The unit can be freely positioned in any slot in the frame. The empty positions in the frame should be blanked off with cover plates.

The supply voltage is to be provided by a **CPS384** power supply unit.

## VIDEO INPUTS AND INDICATOR LEDS

The impedance of the video inputs (BNC female) is 75  $\Omega$ . The nominal input level is 1 Vpp.

Each video input is equipped with the dual colour VIDEO led on the front panel. In case a video signal is present and in nominal level (and the unit detects video synchronization pulses), the VIDEO led is green. If there is no video signal, or the video level is too low, the VIDEO led is yellow.

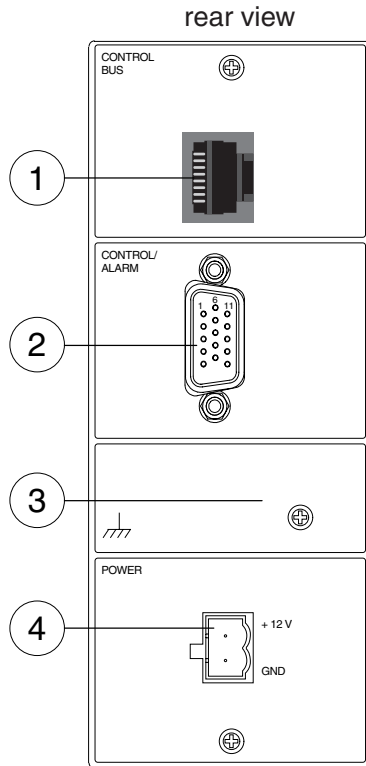

**Picture 2.**

**CMA021 Module Adapter**

- 1) Control bus for management systems (RJ-45 female), not in use.
- 2) Control / alarm interface connector (HD15 female).
- 3) Grounding connection.
- 4) Supply voltage connector.

**STAND-ALONE INSTALLATION**

The unit can be installed for stand-alone use by using a **CMA021** module adapter (see picture 2). The module should be mounted to a vertical surface. The 12V DC supply voltage is supplied by the means of a separate mains adapter with a regulated output, (e.g. **CPS231**). The permitted supply voltage range is 10.5...14V DC. The permitted operational temperature range is from -10 to +55 °C.

Pin	Signal
1	Not used
2	Not used
3	Not used
4	Not used
5	+12 V DC output
6	A - alarm
7	B - alarm
8	CTRL1 (CFO address bus data)
9	CTRL2 (CFO address bus clk)
10	Ground
11	Not used
12	Not used
13	Not used
14	Not used
15	Not used

**Table 1.**

Pin information for the HD15 female connector of the **CMA021** module adapter (with CRR441 installed).

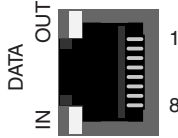

**Picture 3.**

The DATA connector (RJ-45 female). DATA OUT led indicates status of (data ch 2) outgoing data signal and DATA IN led indicates status of (data ch 2) incoming data signal.

## DATA CONNECTIONS

The DATA connector contains two bi-directional data channels (CRT <--> CRR). The connector in use is a **RJ-45 female** connector (see picture 3 and table 3 for detailed description).

The recommended cable for DATA connection is **CIC603** (RJ-45/open wires, see table 2 for detailed description).

Data channel 1 is always in **RS232** mode. The desired data mode for data channel 2 can be selected by using a PC and any terminal type communication software (see separate documentation for **CFO441** terminal software). See table 4 for available data modes for data channel 2. The default factory settings are **RS485-2w + Dwell time 75µs**.

The **DATA IN/OUT** leds indicates the status of data (ch 2) stream and they are also operating synchronously with the data stream. See table 5 for explanation of DATA connector's leds.

Pin	Wire color
1	White / green stripe
2	Green
3	White / orange stripe
4	Blue
5	White / blue stripe
6	Orange
7	White / brown stripe
8	Brown

**Table 2.**

CIC603 cable's pinout / wire colors (RJ-45 male / open wires).

Pin	Signal	TTL	RS422	RS485-2w	RS485-4w	RS232
1	Data 2		in (-)	in / out (-)	in (-)	
2	Data 2	in	in (+)	in / out (+)	in (+)	
3	Data 2		out (+)		out (+)	
4	Data 2	out				
5	Ground					
6	Data 2		out (-)		out (-)	
7	Data 1					out
8	Data 1					in

**Table 3.**

DATA connector's pinout (RJ-45 female).

Mode	Input termination options
TTL	None
RS422	No term (only failsafe)
	Hard bias
	Line bias (120 Ω line impedance)
RS485 - 2w	No term (only failsafe) + Dwell time adjustable 50...10000µs
	Hard bias
	Line bias (120 Ω line impedance)
RS485 - 4w	No term (only failsafe)
	Hard bias
	Line bias (120 Ω line impedance)

**Table 4.**

Available datamodes for data channel 2.

Led	Colour	Status
DATA OUT	Green	Data "1"
	Yellow	Data "0"
DATA IN	Green	Data "1"
	Yellow	Data "0"

**Table 5.**

DATA connector (RJ-45 female) / indicator leds.

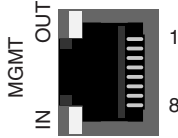

**Picture 4.**

The MGMT connector (RJ-45 female). MGMT OUT led indicates status of outgoing MGMT data signal and MGMT IN led indicates status of incoming MGMT data signal.

## MANAGEMENT (MGMT) DATA CONNECTION

The MGMT connector contains one bi-directional MGMT data channel (**RS232**). The MGMT connection allows locally or remotely (in-band connection via fibre) configuration and monitoring of **CFO441** unit by using a PC and any terminal type communication software (see separate documentation for **CFO441** terminal software).

The connector in use is a **RJ-45 female** connector (see picture 4 and table 7 for detailed description). The recommended cable for MGMT connection is **CIC503** (RJ-45 male/D9 female, see table 6 for detailed description).

The **MGMT IN/OUT** leds indicates the status of MGMT data stream and they are also operating synchronously with the data stream. See table 8 for explanation of MGMT connector's leds.

Pin	RJ-45	D9
1	-	-
2	MGMT out	MGMT in
3	MGMT in	MGMT out
4	-	-
5	Ground	Ground
6	-	-
7	-	-
8	-	-
9	-	-

**Table 6.**

CIC503 cable's pinout (RJ-45 male / D9 female).

Pin	Signal
1	Ground
2	MGMT out (RS232)
3	MGMT in (RS232)
4	Ground
5	Ground
6	Ground
7	Ground
8	Ground

**Table 7.**

MGMT connector's pinout (RJ-45 female).

Led	Colour	Status
MGMT OUT	Green	Data "1"
	Yellow	Data "0"
MGMT IN	Green	Data "1"
	Yellow	Data "0"

**Table 8.**

MGMT connector (RJ-45 female) / indicator leds.



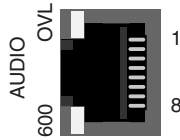

**Picture 5.**

The AUDIO connector (RJ-45 female). AUDIO OVL led indicates status of audio signal level and AUDIO 600 led indicates status of audio input impedance.

## AUDIO CONNECTION

The AUDIO connector contains one bi-directional audio channel line (CRT <--> CRR). The audio input impedance can be set to high impedance (>10 kΩ) or 600 Ω by using a PC and any terminal type communication software (see separate documentation for **CFO441** terminal software). The default factory setting is **600 Ω**.

The connector in use is a **RJ-45 female** connector (see picture 6 and table 10 for detailed description) and the cable in use is e.g. **CIC603** (RJ-45/open wires, see table 9 for detailed description).

The **AUDIO 600** led indicates the status of audio impedance and the **AUDIO OVL** led indicates the status of audio level. See table 11 for explanation of AUDIO connector's leds.

Pin	Wire color
1	White / green stripe
2	Green
3	White / orange stripe
4	Blue
5	White / blue stripe
6	Orange
7	White / brown stripe
8	Brown

**Table 9.**

CIC603 cable's pinout / wire colors (RJ-45 male / open wires).

Pin	Signal
1	Ground
2	Ground
3	Audio output +
4	Audio output -
5	Ground
6	Ground
7	Audio input +
8	Audio input -

**Table 10.**

AUDIO connector's pinout (RJ-45 female).

Led	Color	Status
AUDIO OVL	Green	Audio signal level is good
	Yellow	Audio signal level is too high
	No light	Audio signal is missing
AUDIO 600	Green	Audio input impedance is 600 Ω
	Yellow	Audio input impedance is >10 kΩ

**Table 11.**

AUDIO connector (RJ-45 female) / indicator leds.

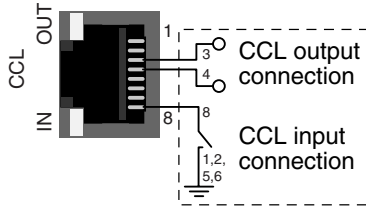

**Picture 6.**

The CCL connector (RJ-45 female). CCL OUT led indicates status of CCL output signal and CCL IN led indicates status of CCL input signal.

### CONTACT CLOSURE LOOP (CCL) CONNECTION

The CCL connector contains one bi-directional contact closure channel line (CRT <--> CRR). The CCL input is a normal short circuit on/off - signal between connector's contact pins 8 and ground (pins 1, 2, 5 or 6).

The CCL output is a normal output relay (dry contact) on/off - signal between connector's contact pins 3 and 4.

The connector in use is a **RJ-45 female** connector (see picture 6 and table 13 for detailed description) and the cable in use is e.g. **CIC603** (see table 12 for detailed description).

The **CCL IN/OUT** leds indicates the status of CCL connection. See table 14 for explanation of CCL connector's leds.

The CCL output channel can be alternatively configured for VSA usage. The default factory setting is CCL usage (**CC1=CC1**).

Pin	Wire color
1	White / green stripe
2	Green
3	White / orange stripe
4	Blue
5	White / blue stripe
6	Orange
7	White / brown stripe
8	Brown

**Table 12.**

CIC603 cable's pinout / wire colors (RJ-45 male / open wires).

Pin	Signal
1	Ground
2	Ground
3	CCL output (output relay)
4	CCL output (output relay)
5	Ground
6	Ground
7	NC
8	CCL input (photodiode cathode)

**Table 13.**

CCL connector's pinout (RJ-45 female).

Led	Color	Status
CCL OUT	Green	CCL output is closed
	Yellow	CCL output is open
CCL IN	Green	CCL input is closed (pin 8 to ground)
	Yellow	CCL input is open

**Table 14.**

CCL connector's leds / indicator lights (RJ-45 female).

## LINK STATUS AND MODULE INDICATOR LEDS

When the optical input signal level is adequate and in synchronization to input data is achieved, the LINK STATUS led on the front panel is green. If optical input signal level is adequate, but no synchronization is achieved the LINK STATUS led blinks green/yellow. If optical input signal is missing or it's level is too low, the the LINK STATUS led is yellow.

When the supply voltage is not in the permitted range (10.5...14 V DC) or there is a transmitter laser failure, the MODULE led colour on the front panel is red. During normal operation MODULE led is blinking green (blinking indicates embedded software is working properly).

## ALARM CONNECTIONS

All alarms at the rear connector of the unit are low open collector outputs, with the capability of 30 V/10 mA switching.

Alarm	Description	Reason
A	Hardware failure	TX laser failure Supply voltage is not in the permitted range
B	Link status alarm	Input optical signal is too low No synchronisation achieved to input data

**Table 15.**

Open collector alarms.

*Note! At the rear of unit is located a DIP switch for factory use only (see example picture below). If this switch is set to "Program" (upper position), the unit goes to "programming state" and then has no normal operation. Default factory setting is "Normal" (lower position). Default factory setting is "Normal" (lower position).*

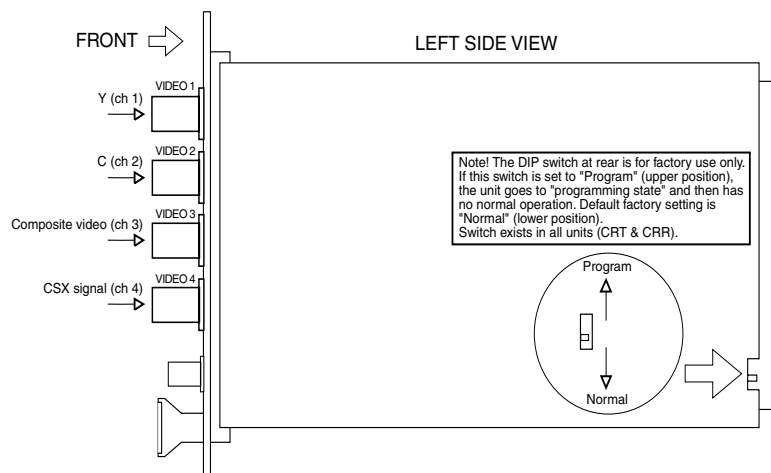

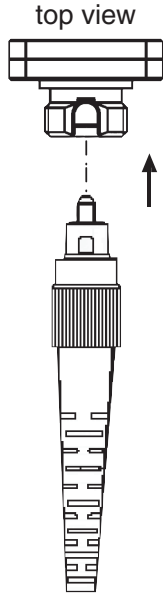

**Picture 7.**  
**FC/PC Connectors**  
 Make sure the key is aligned in the slot properly before tightening!

## VIDEO SOURCE ALARM (VSA)

The CCL output channel can be alternatively configured for VSA usage. When VSA mode is enabled and CRR has not detect video signal (fiber link otherwise operates normally, but only video is missing), the **CCL OUT** led blinks yellow and CCL output pins are closed. VSA have no effect to CRR's CCL input i.e. it can be used normally to transmit CCL information to CRT if VSA is not activated at CRT. In case when VSA is enabled at the same time in both CRT and CRR, then CCL channels are not available for other use. The VSA function can be set on/off by using a PC and any terminal type communication software (see separate documentation for **CFO441** terminal software). The default factory setting is CCL usage (**CC1=CC1**).

See table 16 for explanation of CCL connector's OUT led when VSA function is set active.

*Note! Video detection has 20 sec delay before VIDEO SOURCE ALARM is activated / inactivated.*

Led	Color	Status
CCL OUT	Green on/off blinking	Video OK
	Yellow on/off blinking	Video missing

**Table 16.**

CCL connector (RJ-45 female) / CCL OUT indicator led when VSA is enabled.

## FIBRE CONNECTION

The optical connector is of the type **FC/PC** (see picture 7). The maximum optical input level is -1 dBm (nominal optical output level for return signal is -1 dBm). The link budget for both directions is 20 dB. The operating wavelength is 1310 nm.

When installing the fibre optic cable, do not exceed the minimum bending radius when connecting cable to the system.

*Note! For correct optical operation ensure that all optical connectors are cleaned immediately before mating. Connectors should always be cleaned using high purity alcohol (e.g. methyl or isopropyl alcohol). Dry the surfaces using clean compressed air or other equivalent pressurised gas. The optical connectors on the equipment should always be protected with dustcaps when there is no fibre inserted.*

## Copyright Acknowledgements

Information in this document is subject to change without notice and does not represent a commitment on the part of Teleste Corporation.

**Copyright © Teleste Corporation. All Rights Reserved.**

No part of this document may be reproduced, transmitted, stored in a retrieval system, or translated into any other language without the express permission of Teleste Corporation.

Teleste Corporation  
Video Networks  
P.O. Box 323  
FIN-20101 Turku  
FINLAND  
[www.teleste.com](http://www.teleste.com)



